

L-677 ILLUMINATED MAGNIFIER



100 V

A Multi-purpose magnifier with flexible arm and ring lamp that offers high-quality at a low price.

- Inverter lamp lights up quickly and is flicker-free.
- High-quality, large diameter white lens provides bright crisp images (magnification: 2x).
- Flexible arm can be set as desired, leaving plenty of working space around your hands. Springs are housed inside the arm to create a simple and slim design.
- Equipped with a lens dust / protective cover.

Magnification	2x
Lens diameter	120 mmφ
Light	FCL20 Fluorescent light
Rated voltage / frequency	100 VAC 50 / 60 Hz
Arm length	855 mm
Max. clamp opening width	65 mm
Power consumption	20 W
Weight	2.6 kg

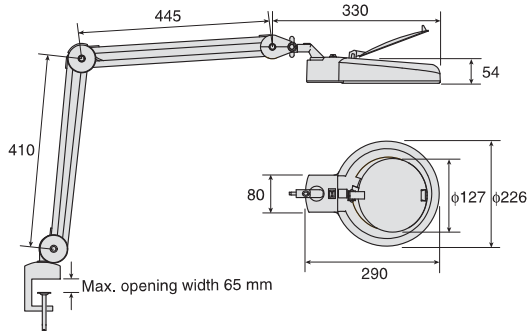

Large diameter white lens

The white lens provides brighter, more vivid images than the blue lens.

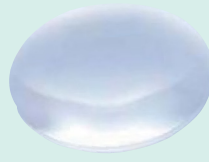

White lens

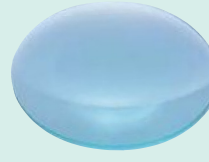

Standard blue lens

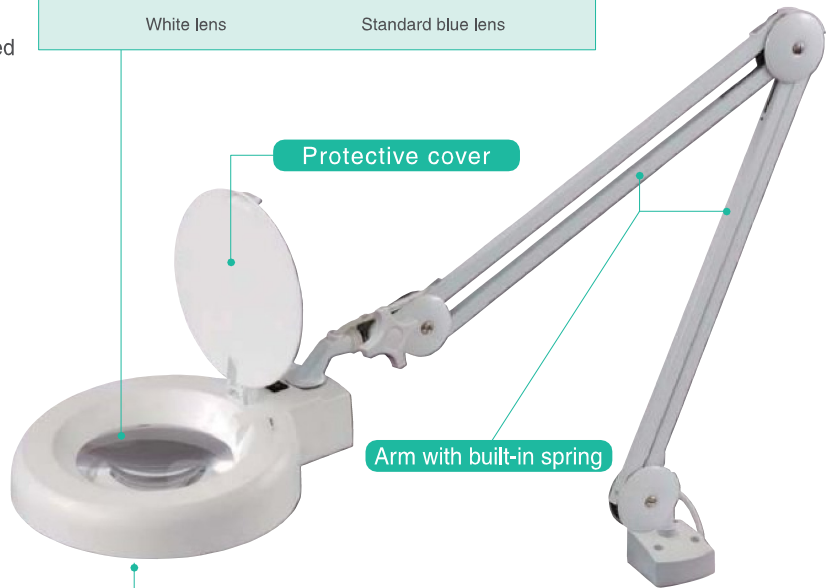

Inverter light

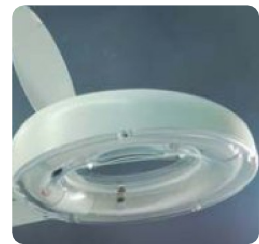
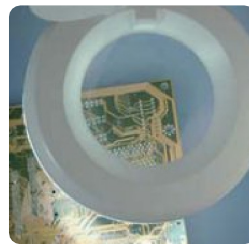

Z-350 / 354 INSPECTION MIRROR / BALL JOINT MIRROR



Z-350

- Permits inspections in hard-to-reach places.

Part No.	OAL mm	Mirror dia. mmφ	Arm length mm	Arm dia. mmφ	Weight g
Z-350	215	24	195	5.5	30
Z-354	200 to 693	30	150 to 640	Max. 8.5	38



Example of Z-354 usage

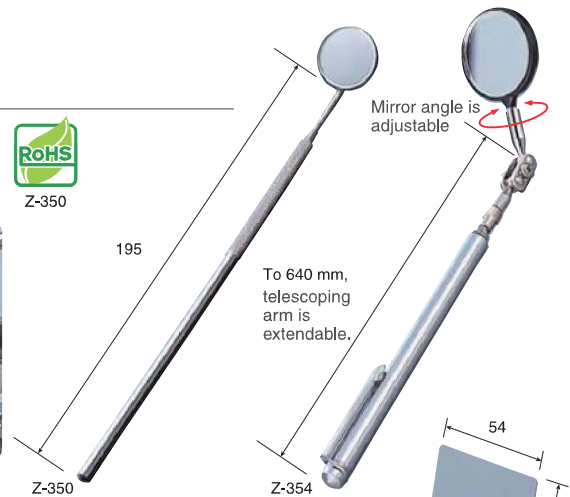

Z-355 STAINLESS MIRROR

Stainless mirror used

- Mirror dimensions: 54 x 86 x thickness 0.4 mm
- OAL: 250 to 740 mm
- Arm length: 150 to 640 mm
- Arm dia.: Max. 8.5 mmφ
- Weight: 50 g



To 640 mm, telescoping arm is extendable.

Cutters & Pliers

Wire strippers

Crimpers

Tweezers

Screwdrivers & Wrenches

Metal working

Parts boxes

Tool cases

Tool kits

Soldering irons & Solder

Parts & Solder removal equipment

Measuring instruments

Optical equipment

Antistatic products

Clean products

Chemical products

Maintenance & Safety products

Stereo Microscopes

Color CCD camera

USB cameras

Zoom lens

LED lights

Lighting equipment

Magnifier